

SHARP

MX-1810U

Digital Full Colour Multifunctional System



Make the Shift to Colour
with This Compact, Reliable MFP

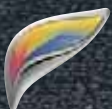

COPY

NETWORK PRINT

NETWORK SCAN

SHARPEDESK

FAX
OPTION

Give Office Communications a Full-Colour Boost

Now there's a practical way to bring colour to office communications. Sharp's MX-1810U provides all the essential copy, print, and network scan functions—in full colour—as well as a convenient fax option.

This compact, energy-efficient A3 MFP delivers 18-page-per-minute output in both colour and B/W and offers superb print quality, thanks to the upgraded second-generation Mycrostoner-HG. An HDD option brings greater efficiency by enabling such advanced functions as integrated document management for enhanced workflow and third-party creation of customised applications via the Sharp OSA (Open Systems Architecture) option.

In the way of data protection, the MX-1810U features highly reliable security solutions. And for easy placement in the office, the MX-1810U boasts an exceptionally lightweight, space-saving frame.

Style, Function, and Ease of Use

The MX-1810U is an attractive, user-friendly addition to any workplace. Designed for easy navigation, the control panel features a 7.0-inch W-VGA touch-screen colour LCD that offers a choice of six screen colours and provides both thumbnail display and data file previews.





COPYING & NETWORK PRINTING

PRODUCTIVE

Super-Efficient Colour and B/W Output

The tandem printing engine with four in-line drums helps the MX-1810U deliver a fast output of **18 cpm/ppm*** in full colour and in B/W. And the first copy comes out in just **10.2 seconds** in full colour and **8.8 seconds** in B/W. What's more, its short, straight paper path minimises misfeeds to save you paper and toner costs.

* A4 (8 1/2" x 11"), long-edge feeding



Productive Collated Output from Memory

The MX-1810U's Scan Once/Print Many function only requires a single scan of a multi-page original for copying, and the RIP Once/Print Many function only needs to download print data once from the PC for printing. The machine then automatically saves the data into memory and outputs **collated** sets of copies or printouts in the proper page order (electronic sorting).



Multi-page original is scanned... stored in memory... and output in proper page order (or print data sent from PC)

Built-In Stackless Duplex Module

The MX-1810U can make **two-sided copies and printouts** using its built-in stackless duplex module, effectively reducing paper costs as well as saving filing space. Duplex copying is even more effective when the duplex module is used together with the optional **100-sheet RSPF** (reversing single pass feeder), which efficiently feeds in either one- or two-sided originals.

Job Build for Large-Volume Scanning

The MX-1810U easily handles large-volume copy jobs exceeding the RSPF's 100-sheet*¹ capacity. For example, a 270-sheet original can be scanned as batches of 100 + 100 + 70 sheets and automatically stored on the MX-1810U's hard disk*². Users can then print the entire document in a single run.

*1: A4 (8 1/2" x 11"), 80 g/m²

*2: Requires optional MX-HD11. The number of pages that can be stored for the Job Build function depends on the machine's HDD capacity and other conditions.

Large Paper Capacity

For high-volume work, the MX-1810U can accommodate an optional stand with 3 x 500-sheet paper drawers for a total capacity of **2,100 sheets**. When a tray runs out of paper, the **Auto Tray Switching** function automatically switches to another paper tray filled with the same size paper, allowing you to do extra-large volume jobs without worry.



Network Tandem Function*

When two MX-1810Us are connected to the same office network, you can use both simultaneously to double copying/printing output to up to **36 cpm/ppm**. Large-volume jobs can be completed with ease, enabling you to meet tight deadlines.

* Requires optional MX-HD11 and MX-PB14.

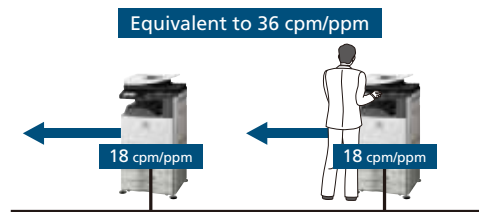

Convenient Copy Previews*

To prevent errors in copying, the MX-1810U shows previews of copy jobs on its LCD before actually executing them. And with previews, it's easy to confirm image editing, scan settings, and other such items.



2-in-1 copying (preview)

* Requires optional MX-HD11.

NETWORK-READY

Supports Most Office Environments

- The MX-1810U works as a network printer with the latest and most commonly used operating systems and network protocols, including **IPv6**, and even in mixed OS environments.
- The MX-1810U supports the **PCL6** printer language.* For compatibility with **PostScript 3**, the MX-PK11 PS3 Expansion Kit is available.*

* Requires optional MX-HD11 and MX-PB14.

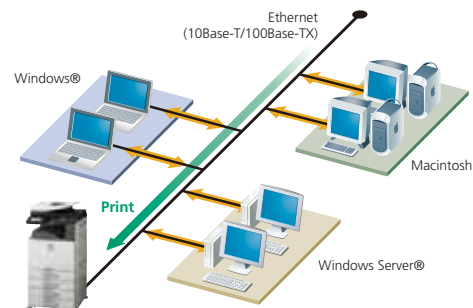

SUPERB PRINT QUALITY

Improved Imaging System



Sharp thoroughly revamped its imaging process for the MX-1810U; now a high-performance processor, a new developer, and the second-generation **Mycrostoner-HG** (High Grade) combine to provide breathtaking image quality. The new toner expands the colour reproducibility range for a more natural rendering of clear blue skies, emerald green oceans, and other colour images. And the smaller particle size of the toner and the developer allows for reduced graininess and clear reproduction of fine lines, fine text, and halftone colours.



Crisp, Clear Text and Images



Employing digital smoothing technology enhances the print resolution to the equivalent of **9,600 x 600 dpi** for incredibly smooth reproduction of fine lines. Fine-grained photographs, detailed illustrations and graphs, and small text come out crisp and clear.

High-Quality Page Description Language



To ensure high-quality image processing, the MX-1810U uses **Sharp Advanced Printing Language-c**, Sharp's original page description language (PDL) that delivers superb performance and print quality. The MX-1810U is also compatible with PCL6 and PS3 (option).

Easy, High-Quality Copying



Auto Colour Selection automatically determines whether a page is colour or *B/W* and selects the appropriate copy mode for that page. **Auto Colour Mode** analyses the contents of each page, distinguishing between different components, such as photos and text. These are what allow the MX-1810U to print out maps with crisp, clear text and to automatically remove the background colour on newspaper and magazine copies for clearer output.

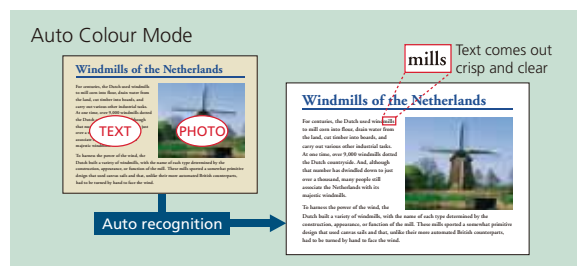

VERSATILE

Versatile Paper Handling



The MX-1810U accommodates a wide range of paper sizes, from **A5R (5 1/2" x 8 1/2"R)** to **A3 wide (12" x 18")**. You can do A3 (11" x 17") **full-bleed printing** onto **A3-wide (12" x 18")** paper, without loss of image area. And the MX-1810U can handle heavy paper stock up to **256 g/m²**, overhead transparencies, and other types of paper, further expanding the range of printing applications.

Image Editing Functions



The MX-1810U includes colourful editing functions made possible by digital technology.

- **Multi-Page Enlargement** divides an image onto separate sheets for making posters up to A0 x 2 (44" x 68") in size.
 - **Photo Repeat** places multiple copies of an image onto a single sheet.
 - **Mirror Image** makes a reverse image of the original.
 - **XY Zoom** adjusts the horizontal and vertical ratios independently.
 - **B/W Reverse** reverses the black and white of an image.
- Please see specifications for a list of available convenient functions.

Various Copy/Print Applications



Copy & Print

- **Watermark***1 prints a user-selected watermark, such as "Urgent," on each page to indicate the status of the document.
- **Tab Copy / Tab Print***2 can copy or print directly onto tabs on document separators and insert them into assigned positions.
- **Multi-Shot** copying and **N-up** printing
- **Pamphlet Style** copying/printing
- **Cover/transparency** insertion

*1: Requires optional MX-HD11. *2: Tab print requires optional MX-HD11 and MX-PB14.

Print

- **Direct Print***1 allows **PDF***2, **TIFF**, **JPEG**, or **XPS***3 files to be printed without using the printer driver or opening applications.
- **Carbon Copy Print** mode automatically outputs multiple printouts of the same data on plain and/or coloured paper; convenient for invoices and purchase orders.
- **Form Overlay** can store office document formatting such as letterheads and overlay contents in colour, eliminating the need for pre-printed paper.
- **Barcode font** compatibility*4

Note: The above functions require optional MX-HD11 and MX-PB14.

*1: Direct printing may not support all PDF, TIFF, JPEG, and XPS formats. *2: Direct PDF printing requires optional MX-PK11. *3: Direct XPS printing requires optional MX-PUX1 and MX-SM10. *4: Requires optional MX-PF10.

Copy

- **Book Copy** is convenient for compiling copies of a book or bound originals into pamphlet format.
- **Card Shot** enables one-touch copying of both sides of a card (credit cards, ID cards, etc.) onto a single page.
- **Colour Stamp** labels your copies with page numbers, the date or text such as "Urgent" in up to four different colours.
- **Mixed Size Original Copy** mode automatically distinguishes documents of mixed sizes* (such as A3/B4, B4/A4, etc.) fed through the RSPF and chooses the appropriate paper.

* Some restrictions apply when combining paper sizes of different format series.

IMAGE SENDING

A3 Colour Network Scanning

SCAN

The MX-1810U works as a **full-colour network scanner**. Converting any type of paper-based document, up to A3 (11" x 17") in size, into an editable digital file is as easy as making a copy. The MX-1810U supports TIFF, PDF, encrypted PDF, XPS, and JPEG file formats. Enhanced scan performance improves the legibility of extremely fine text and allows vivid colour reproduction in scanned documents. And **Auto Colour Selection** chooses the right mode for scanning originals containing both colour and B/W pages (see page 4).

Quick Scanning

SCAN

FAX

For both colour*¹ and B/W documents, the MX-1810U carries out scanning at the impressive speed of **50 opm***² (originals per minute) and can complete large scan jobs with ease and efficiency.

*1: Faxing is available in B/W only. *2: Single-side scanning

Multiple Distribution of Scanned Files

SCAN

FAX

With the touch of a few on-screen buttons, you can choose different ways to distribute your scanned documents. **Scan to E-mail** sends documents as an e-mail attachment. **Scan to FTP Server** scans documents directly to an FTP server for storage. **Scan to Desktop** sends scanned documents directly to your PC desktop. **Scan to Network Folder (SMB)** sends files to a shared folder on a networked Windows PC. **Scan to USB Memory** scans documents directly to USB memory devices. And **Scan to Fax** enables conventional faxing or Internet faxing.

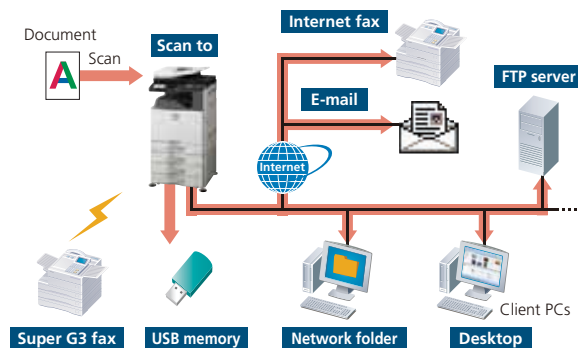

LDAP Support

SCAN

FAX

Built-in LDAP (lightweight directory access protocol) support eliminates the need to enter or register full addresses. By entering the first few letters of the recipient's name, the MX-1810U displays a list of possible matches from your company's LDAP server. Selected addresses can be stored to the MX-1810U's address book.



Skip Blank Page Function

SCAN

When scanning and sending a multi-page document, the MX-1810U automatically recognises and skips over any pages without content, reducing both data size and transmission time.

High-Speed Faxing

FAX

The optional MX-FX11 Fax Expansion Kit turns the MX-1810U into a 33.6 Kbps **Super G3 fax** machine. Using JBIG compression technology, the MX-1810U can send an A4 (8 1/2" x 11") size page in under 3 seconds*. Use the 100-sheet RSPF to further boost faxing efficiency. And, because **Quick On-Line Transmission** can start dialling and transmitting as soon as the first page is scanned into memory, you can send documents in **much less time**.

* Based on Sharp's standard chart with approximately 700 characters (A4 or 8 1/2" x 11" long-edge feeding) at standard resolution.

PC-Fax/PC-Internet Fax

FAX

Directly send a document created on your PC to a recipient's fax machine via a phone line or the Internet without printing to paper. Save time and paper costs while retaining original document quality.

Note: PC-Internet Fax requires optional MX-HD11 and MX-FWX1; PC-Fax requires MX-FX11.

Internet Fax

FAX

Economically send and receive faxes to and from other ITU-T T-37-compliant Internet fax machines via the Internet. The MX-1810U supports **Direct SMTP**; outgoing Internet faxes do not go through your mail server, making transmission faster and cheaper.

Note: Requires optional MX-HD11 and MX-FWX1.

Paperless Faxing with Inbound Routing

FAX

Paperless faxing with inbound routing lets you check incoming faxes via e-mail before printing. It can also forward incoming faxes to another fax/Internet fax machine, an FTP server, a network folder (SMB), or a PC desktop. Files can be saved in either PDF or TIFF (single/multi).

Note: Requires optional MX-HD11.

Other Key Features

Scan & Fax

- **One-touch auto dial keys** register up to **1,000** numbers for frequently used destinations
- **Broadcast transmission** to up to 500 destinations
- **Programme keys** (up to 48 keys) are available to set up frequently used transmissions for instant recall
- **Easy text entry*** lets you enter addresses, file names, subject titles or messages from the LCD control panel
 - * Only addresses can be entered for faxing.
- **Mixed size original scanning** automatically distinguishes documents of mixed sizes fed through the RSPF

Fax

- **Duplex transmission/reception** sends and prints out two-sided documents
- **SD memory card backup** ensures documents remain safely backed up in memory, even in the event of a power failure
- **Rotation transmission/reception** rotates incoming and outgoing faxes to match the direction of the printing paper
- **Fax destination confirmation** allows users to reconfirm fax numbers before sending to prevent transmission errors

SECURITY

Security You Can Count On

The MX-1810U protects your business assets and brings you peace of mind. Reliable network and data security functions safeguard confidential information and help prevent unauthorised use of the MFP.

Encrypted PDF with Password Protection

To prevent unauthorised viewing of confidential image data, the MX-1810U enables users to password protect and encrypt PDF data. By setting a password when scanning, users can transmit a PDF over the network in encrypted format. Then, after transmission, viewers will only gain access to the encrypted PDF after successfully re-entering the chosen password.

Note: Direct printing of encrypted PDF files requires optional MX-HD11, MX-PB14, and MX-PK11.

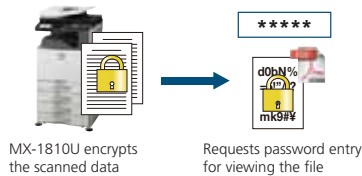

Data Initialisation

The MX-1810U's initialisation function allows confidential information to be erased at the administrator's discretion via the MFP's system setting. Initialising an MFP when it's taken out of service prevents important resources, such as customer information and intellectual property, from leaking out and provides considerable peace of mind.

Secure Network Access

The MX-1810U's **IP/MAC address filtering** function provides highly secure operation by restricting access to the MX-1810U on your office network. Only PCs that have either their IP address or MAC (media access control) address registered are allowed to use the MX-1810U. Attempted access from an unknown IP or MAC address will be denied, preventing unauthorised use. The MX-1810U also supports the **IEEE 802.1X** standard for port-based network access control, which blocks all access from unauthorised devices.

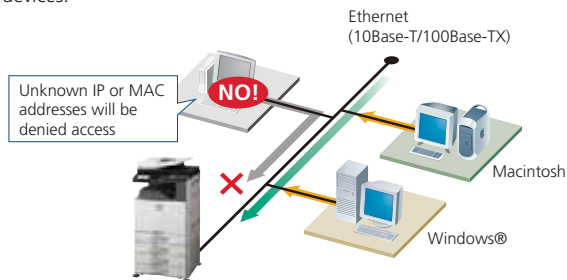

Secure Sockets Layer

SSL (secure sockets layer) enables the encryption of data communications to prevent data leakage through the network when printing via IPP, browsing secure Web pages (HTTPS), or communicating via e-mail (SMTP and POP3) or FTP (FTPS).

User Authentication

The MX-1810U prevents unauthorised use by requiring **passwords** for machine access. This safeguarded solution can register up to 1,000 users in **three access levels** as Administrator, User, or Guest and can designate to which function user authentication applies. The MX-1810U can, for example, be set to allow B/W copying by all users while restricting colour copying to designated users. And the MX-1810U works with an **external Active Directory server** to extend user authentication to multiple MFPs and a greater number of users.



User authentication

IPv6 and IPsec Support

The MX-1810U supports the **IPv6** Internet protocol. An obligatory part of IPv6 is **IPsec** (IP Security), a set of protocols for securing Internet protocol (IP) communications. IPsec encrypts and authenticates traffic between specified parties, giving IPsec-compatible products an extremely high level of network security.

Scan to Me Function

Scan to Me lets a logged-in authorised user send scanned data to his/her own e-mail address simply by pressing the start button. This eliminates the need to manually enter or select the address, thereby preventing documents from being sent to the wrong address.



DOCUMENT MANAGEMENT

Document Management on the Hard Disk

You can save processed job data in designated folders on the MX-1810U's hard disk*, making it easy to instantly recall saved documents or jobs for printing and sending at a later time. This contributes greatly to efficient sharing and distribution of information in your business operations.

* Requires optional MX-HD11.

Easy Access to Stored Files

Documents stored on the hard disk can be quickly and easily searched and accessed from the control panel's LCD via thumbnail displays and file previews or through a Web browser.

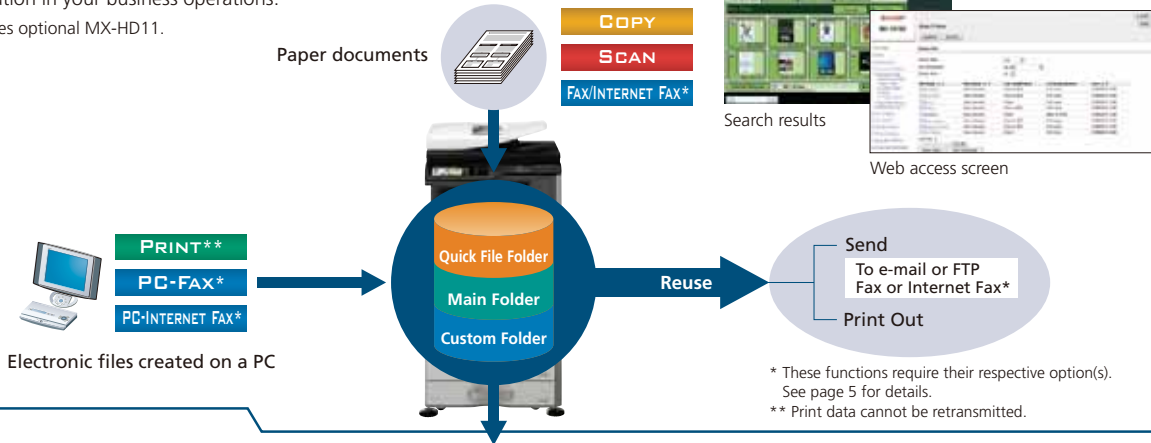

Quick Filing

Up to **10,000 pages** or 3,000 files*¹ that have been copied, printed, scanned, or faxed*² can be stored by job on the hard disk in a Quick File Folder. You can easily reuse saved data without having to reload or rescan the original.

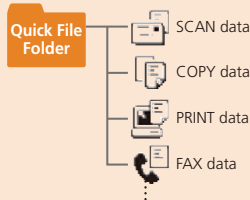

Advanced Filing Function

Up to **20,000 pages** or 3,000 files*¹ that have been copied, printed, scanned, or faxed*² can be stored by job on the hard disk in up to 1,000 folders with customised names and locations. Enhanced security features require users to enter a 5- to 8-digit password to access secure folders, protecting your sensitive data. Storage options include:

- **Main Folder** – You can store processed files by user name in the main public folder and share them across the workgroup. Any file name and a PIN code can be assigned to each saved job.
- **Custom Folder** - Up to 1,000 private folders (named as desired) can be created within the Custom Folder. When saving a file in a private folder, any file name can be assigned. A PIN code can be applied to both private folders and files.

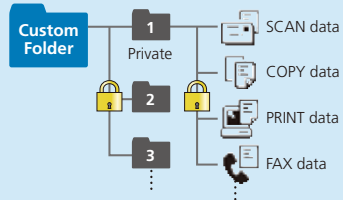
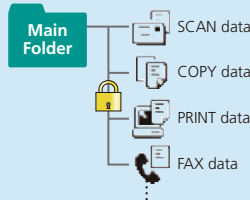

*1: Measured using Sharp's standard chart (A4 with 6% coverage, B/W). The Quick File Folder shares the HDD with the Job Build function. The storage capacity will be less for colour pages.

*2: For fax and Internet fax jobs, only transmitted data (not received faxes) can be saved in the Document Filing function.

Sharpdesk for Total Document Management

Sharpdesk is an original Sharp application that provides integrated desktop management of documents in over **200 file formats**, including scanned paper-based documents and those created with popular applications such as Word. It allows you to organise, edit, search, and distribute your documents, all with simple drag-and-drop operation.

- Intuitive desktop display features **thumbnail** viewing
- Sharpdesk Imaging provides **annotation** tools for paper-free proofreading
- Sharpdesk **Composer** combines different types of files into a single document
- **Optical character recognition** converts documents into editable text files
- **Output zone** distributes files to e-mail, printers, and other applications
- **File search** allows searching by file name, keyword, or thumbnail

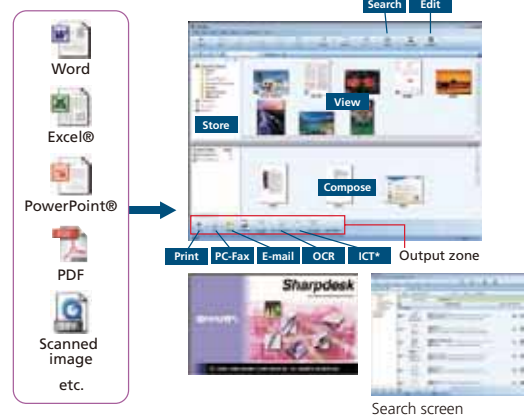

* Image Compression Tool for converting images into compact PDF files

DEVICE MANAGEMENT

Integrated Device Management

The MX-1810U allows for easy programming of complex settings and makes it possible for a system administrator to manage multiple devices from a single location. The result is minimum time and effort and maximum work efficiency.

Web-Based System Settings

Administrators can configure system settings such as address book control, document filing management, and user control (accounting) from either over the network or from the control panel of the MX-1810U.



Web-based device management

User Control

The MX-1810U has capabilities to **restrict machine access and usage**. Easily manage overall running costs by setting access rules through a Web browser to limit or restrict functions, such as the printing out or copying of large-volume colour documents.

- Authority Groups – Use of each function can be restricted individually.
- User control and account – Up to 1,000 password-protected user accounts can be created for customised access. Accounts can be set up for individuals, groups or departments, in conjunction with the authority group setting. Maximum limits for printing or copying pages can be set for each account.

Remote Diagnosis

The MX-1810U can be monitored remotely through a Web browser. In the event of a problem, such as a low amount of toner, an alert is displayed on the Web page. And, the E-Mail Status and Alert function generates e-mail messages to notify the administrator when action or maintenance is required.

Network Utility Software

- **Sharp Remote Device Manager (SRDM)** makes printer networks easier to manage by allowing administrators to customise monitored items and view settings such as the IP address directly from their PC through a standard Web browser.
- If the MX-1810U is low on paper or toner, the **Printer Status Monitor** will alert you in the form of easy-to-understand graphics, allowing you to avoid problems before they arise.



Web-based SRDM



Printer Status Monitor

Device Cloning

Machine settings can be copied conveniently to another MX-1810U via a Web browser in XML format, making it easy to clone machines in a networked environment. With Device Cloning, the administrator no longer needs to set up individual machines one by one, thereby making his/her job a lot easier.

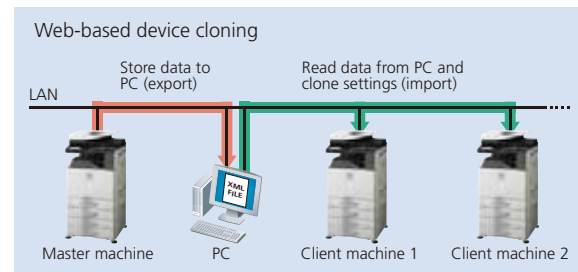

Remote Operation

With the MX-1810U's Remote Operation function, the same control panel screen found on the MFP can be displayed on the screen of a remote, office-networked PC, allowing the MFP to be operated via that PC.* This function can, for example, enable the administrator to guide an MFP user in need of help through necessary procedures. It also allows users, such as the physically challenged, who might have difficulty accessing the MFP control panel, to operate the MFP remotely, via the PC.

* Requires VNC application.



ENVIRONMENT- & USER-FRIENDLY

ENVIRONMENTALLY ADVANCED

Eco-Friendly Supplies

Integrating Sharp's environmentally advanced supplies, the MX-1810U takes ecological performance to a whole new level. Second-generation Mycrostoner-HG offers a significantly **lower consumption rate** than conventional toner, while the **longer-life photoconductor** delivers higher performance than previous models.

Environmentally Conscious Design

- A **short warm-up time** of 45 seconds contributes to reduced overall energy consumption.
- Based on prior usage patterns, the MX-1810U automatically determines the optimal length of time to let elapse before going into auto power shut-off mode, helping reduce overall power consumption.

- Conforming to the **ENERGY STAR**® programme, an international system identifying energy-efficient products, the MX-1810U has two levels of **energy-saving modes** to reduce or shut off electricity after a period of inactivity. And pressing the **power save key** after a job is finished immediately puts the MX-1810U into auto power shut-off mode for further cutbacks on running costs.
- In **support of the RoHS directive**, which restricts the use of hazardous substances, Sharp has fully eliminated harmful lead and chromium in all MX-1810U parts and materials.



Power save key

EASY OPERATION

7.0-Inch Touch-Screen LCD

The MX-1810U features a logically designed control panel with a wide, clear, WVGA-resolution touch-screen LCD. Easy-to-follow guidance puts step-by-step instructions on the LCD to guide you through various operations and functions. Pushing the **Home** button, even in the middle of an operation, takes you back to the Start screen. Programming the most frequently used functions and settings into **My Menu** gives you quick and easy access to them. And using the included stylus pen provides controlled, accurate touch-screen operation.

Sharp OSA (Open Systems Architecture)

The MX-1810U supports the Sharp OSA* development platform. This innovative technology allows users to interact with critical business and network applications and/or external account software right from the LCD control panel, offering a new realm of control and convenience. And since Sharp OSA utilises industry-standard network protocols, such as XML and SOAP, the MX-1810U can easily integrate with document management systems, enterprise resource planning software, workflow applications, and more.



* Requires optional MX-HD11 and MX-AMX2 and/or MX-AMX3.

Sharp OSA Network Scanner Tool

This client-based scan-to-desktop option is the ideal document management system for small workgroups or offices that don't have servers. Sharp OSA Network Scanner Tool provides centralised scan/print user profiles to give everyone in the office easy one-touch scanning to their PC from any networked MFP—without complicated settings. Scanned documents can be quickly and easily printed, filed, previewed, shared, and stored to save time and improve document workflow. And Sharp OSA Network Scanner Tool automatically names PDF files based on scanned-document titles and can convert scanned documents into text with the OCR engine to create searchable PDF files.

Easy-Grip Handles

Easy-grip handles on the MX-1810U reflect a universal design that allows the paper drawers to be grasped from the top as well as the bottom for easy opening and closing.



Thumbnail Display and Previews*

Making the search for files easier and more convenient than ever, thumbnails and up-close previews of Document Filing data files, as well as conventional file names, can be displayed on the MX-1810U's LCD control panel. And to help users decide which documents to print out or forward to others, the LCD can also display thumbnails and previews of incoming faxes and Internet faxes. The MX-1810U even prevents errors in copying, scanning, or saving documents to its hard disk by showing previews of those jobs on the LCD before actually executing them, making it easy to confirm image editing, scan settings, and other such items.

* Requires optional MX-HD11.



Thumbnails



Preview

Job Status Screen

Whether printing or copying, the control panel displays a list of all jobs, showing you at a glance the jobs in progress and the position of your job in the queue. And, with a few quick touches of the LCD screen, the **Priority Printing** function lets you easily **change the job queue order** or delete jobs that are no longer needed.



Job status

OPTIONS

System Configuration

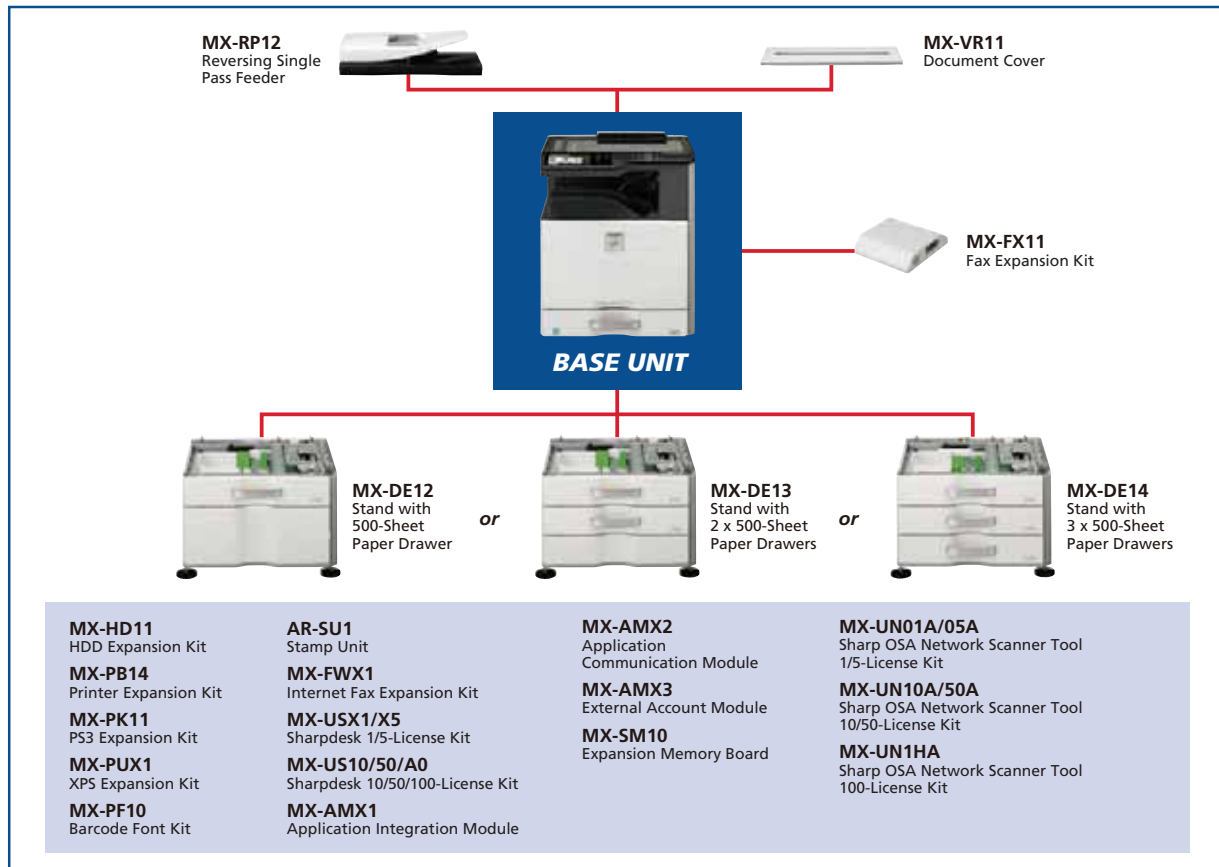

Certain options may not be available in some areas.

Specifications for Options

MX-RP12 Reversing Single Pass Feeder

Scan speed (copy)	Colour	36 opm (one-sided), 17 opm (two-sided)
(A4, 8 1/2" x 11)	B/W	50 opm (one-sided), 20 opm (two-sided)
Paper size		A3 to A5 (11" x 17" to 5 1/2" x 8 1/2")
Paper capacity		100 sheets (80 g/m ²)

MX-FX11 Fax Expansion Kit

Compression method	MH/MR/MMR/JBIG
Communication protocol	Super G3/G3
Modem speed	33,600 bps to 2,400 bps

MX-DE12 Stand with 500-Sheet Paper Drawer

Paper size	A3 to A5R (11" x 17" to 5 1/2" x 8 1/2"R)
Paper capacity	500 sheets (80 g/m ²)

MX-DE13 Stand with 2 x 500-Sheet Paper Drawers

Paper size (upper and lower tray)	A3 to A5R (11" x 17" to 5 1/2" x 8 1/2"R)
Paper capacity (upper and lower tray)	500 sheets each (80 g/m ²)

MX-DE14 Stand with 3 x 500-Sheet Paper Drawers

Paper size (upper/middle/lower tray)	A3 to A5R (11" x 17" to 5 1/2" x 8 1/2"R)
Paper capacity (upper/middle/lower tray)	500 sheets each (80 g/m ²)

Sharpdesk System Requirements

Supported OS	Windows® XP (SP2) Professional/Home Edition, Windows Vista®, Windows® 7
Hard disk	Minimum requirement of operating system used plus at least 500MB to store Sharpdesk and Network Scanner Tool programmes
CPU	Pentium® or equivalent processor (Windows XP: 800 MHz 32-bit/64-bit processor; Windows Vista and Windows 7: 1 GHz 32-bit/64-bit processor)
Memory	Windows XP: 512MB RAM; Windows Vista and Windows 7: 1GB RAM/2GB RAM (Windows 7 64-bit)
Monitor	Windows XP: SVGA display; Windows Vista and Windows 7: Direct X9 support with 128MB video RAM

SPECIFICATIONS

General	
Type	Desktop
Engine speed (colour & B/W)	Max. 18 cpm/ppm (A4, 8 1/2" x 11", long-edge feeding)
Paper size	Max. A3 wide (12" x 18"), min. A5R (5 1/2" x 8 1/2" R)
Paper capacity	Standard: 600 sheets (500-sheet tray and 100-sheet multi-bypass tray) Maximum: 2,100 sheets
Paper weight	Tray: 60 g/m ² to 209 g/m ² (16 lbs bond to 110 lbs index) Multi-bypass tray: 55 g/m ² to 256 g/m ² (13 lbs bond to 140 lbs index)
Warm-up time*1	45 sec.
Memory	[Standard] Copy/print (shared): 1GB [Option] Print: 1.5GB 160GB HDD*2
Power requirements	Rated local AC voltage ±10%, 50/60 Hz
Power consumption (max.)	1.84 kW (220 to 240V)
Dimensions (W x D x H)*3	583 x 623 x 717 mm (22 31/32" x 24 33/64" x 28 15/64")
Weight (approx.)*3	65 kg (143.3 lbs)
Features	Job build*4, document filing*4, pre-heat/auto power shut-off modes, user authentication (1,000 accounts), toner save mode, preview*4, thumbnail view*4*5

Copier	
Original paper size	Max. A3 (11" x 17")
First copy time*6	Full colour: 10.2 sec. B/W: 8.8 sec.
Continuous copy	Max. 999 copies
Resolution	Scan (colour): 600 x 600 dpi Scan (B/W): 600 x 600 dpi, 600 x 400 dpi, 600 x 300 dpi Print: 600 x 600 dpi, 9,600 (equivalent) x 600 dpi (depending on print mode)
Gradation	Equivalent to 256 levels
Zoom range	25 to 400% (25 to 200% using RSPF) in 1% increments
Preset copy ratios	Metric: 10 ratios (5R/5E), inch: 8 ratios (4R/4E)
Features	Auto paper selection (mixed/random size feeding), auto magnification selection, paper type selection, auto tray switching, rotation copy, electronic sorting, network tandem copy, book copy, margin shift, dual page copy, multi-shot (4-in-1, 2-in-1), cover/transparency/tab page insertion, pamphlet copy, 2-sided copy orientation change, XY zoom, B/W reverse, mirror image, duplex copy, job reservation, 48 job programmes, photo repeat, irregular original/paper size input, stamps (date, page number, text, stamp), multi-page enlargement, tab copy, centering, proof copy*4, auto colour mode, auto colour selection, auto calibration, watermarks*4, sharpness, card shot, original count, edge/centre/side erase

Network Scanner	
Scan method	Push scan (via control panel), pull scan (TWAIN-compliant application)
Resolution	Push scan: 100, 200, 300, 400, 600 dpi Pull scan: 75, 100, 150, 200, 300, 400, 600 dpi 50 to 9,600 dpi via user setting*7
File formats	TIFF, PDF, encrypted PDF, JPEG (colour only), XPS*8
Scanner utility	Sharpdesk
Scan destinations	Scan to e-mail/desktop/FTP server/network folder (SMB)/USB memory
Features	Internet fax*9 (supports direct SMTP), PC-Internet fax transmission*9, auto colour mode, mixed size original scanning, LDAP support, direct entry (address, subject, message), 500 group dials, 1,000 one-touch dials, 48 job programmes, broadcasting, long original scanning (max. 1,000 mm)*10, auto colour selection, card shot, original count, edge/side erase

Document Filing (optional MX-HD11 required)	
Document filing capacity	Main and custom folders: 20,000 pages*11 or 3,000 files Quick file folder: 10,000 pages*11 or 3,000 files
Stored jobs*12	Copy, print, scan, fax transmission
Storage folders	Quick file folder, main folder, custom folder (max. 1,000 folders)
Confidential storage	Password protection

Network Printer	
Resolution	600 x 600 dpi, 9,600 (equivalent) x 600 dpi
Interface	USB 2.0, 10Base-T/100Base-TX
Supported OS*13	Windows Server® 2003/2008, Windows® 2000/XP, Windows Vista®, Windows® 7, Mac OS 9.0 to 9.2.2, Mac OS X 10.2.8, 10.3.9, 10.4.11, 10.5 to 10.5.8, 10.6 to 10.6.5
Network protocols*13	TCP/IP (IPv4, IPv6), IPX/SPX (NetWare), NetBEUI, EtherTalk (AppleTalk)
Printing protocols	LPR, Raw TCP (port 9100), POP3 (e-mail printing), HTTP, Novell Printserver application with NDS and Bindery, FTP for downloading print files, EtherTalk printing, IPP
PDL (emulation)	Standard: Sharp Advanced Printing Language-c Option*14: PCL 6 emulation, PS3 emulation, XPS
Available fonts	80 fonts for PCL, 136 fonts for PS3 emulation
Features*12 *15	Network tandem print, RIP Once/Print Many, job retention (proof print, confidential print), direct PDF/TIFF/JPEG/XPS printing, carbon copy print, duplex print, font/form download, pamphlet style, Sharp Remote Device Manager, printer status monitor, IP/MAC address filtering, port/protocol management, binding edge, N-up (2/4/6/8/9/16), paper tray selection, cover/transparency insertion, fit to page, watermarks, form overlay, auto configuration, barcode font compatibility, tab print, poster print, margin shift, secure network communications (SSL and IPsec [LPPD])

B/W Facsimile (optional MX-FX11 required)	
Compression method	MH/MR/MMR/JBIG
Communication protocol	Super G3/G3
Transmission time	Less than 3 seconds*16
Modem speed	33,600 bps to 2,400 bps with automatic fallback
Transmission resolution	From Standard (203.2 x 97.8 dpi) to Ultra Fine (406.4 x 391 dpi)
Recording width	A3 to A5 (11" x 17" to 5 1/2" x 8 1/2")
Memory	512MB, max. 1GB*4
Grey scale levels	Equivalent to 256 levels
Features	Duplex transmission/reception, quick on-line transmission, error correction mode, LDAP support, 500 group dials, 1,000 one-touch dials, 48 job programmes, broadcasting number registration, F-Code compatibility (confidential, relay broadcast), polling, memory transmission/reception, auto reduction (transmission/reception), rotation transmission/reception, print actual size, 2-in-1 transmission, long original transmission (max. 1,000 mm), PC-Fax transmission, timer transmission, inbound routing*4 to fax/Internet fax/e-mail/FTP server/network folder (SMB)/PC desktop, activity report, anti-junk fax, dual page scan, card shot, edge/side erase, mixed size original scanning, original count

- *1: Design and specifications are subject to change without prior notice.
- *2: HDD capacity depends on procurement and sourcing status.
- *3: Including document cover.
- *4: Optional MX-HD11 required. Job Build function also requires optional MX-RP12.
- *5: Thumbnails of Document Filing data files and incoming faxes.
- *6: Long-edge feeding of A4 (8 1/2" x 11") sheets from 1st paper tray, using document glass, without Auto Colour Selection and Auto Colour mode, MFP in fully ready condition. May vary depending on operating conditions and environment.
- *7: Resolutions higher than 600 dpi are interpolated.
- *8: To view XPS files on PCs not running Windows Vista, you must have the XPS Viewer application installed.
- *9: Optional MX-HD11 and MX-FWX1 required.
- *10: B/W documents only, scanned at under 400-dpi resolution. Max. 800 mm for Internet faxing or when scanning at 600 x 600-dpi resolution.
- *11: Measured using Sharp's standard chart (A4 with 6% coverage, B/W). The Quick File Folder shares the HDD with the Job Build function. The storage capacity will be less for colour pages.
- *12: Some features require option(s).
- *13: Optional MX-PK11 required for Mac OS and EtherTalk.
- *14: PCL requires optional MX-HD11 and MX-PB14. PS requires optional MX-HD11, MX-PK11, and MX-PB14. XPS requires optional MX-HD11, MX-PUX1, MX-PB14, and MX-SM10 (1GB).
- *15: Some features are not available according to the printer driver used.
- *16: Based on Sharp's standard chart with approx. 700 characters (A4 or 8 1/2" x 11" long-edge feeding) at standard resolution in Super G3 mode, 33,600 bps, JBIG compression.

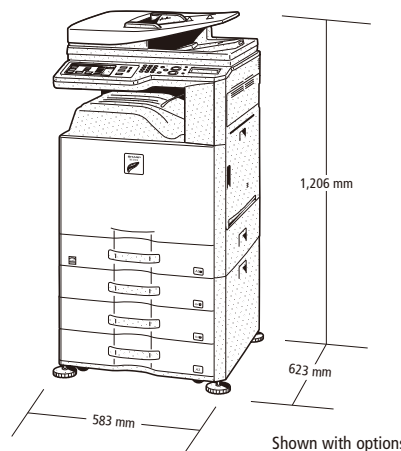

*1: At rated voltage, 23°C (73.4°F). May vary depending on operating conditions and environment.

*2: HDD capacity depends on procurement and sourcing status.

*3: Including document cover.

*4: Optional MX-HD11 required. Job Build function also requires optional MX-RP12.

*5: Thumbnails of Document Filing data files and incoming faxes.

*6: Long-edge feeding of A4 (8 1/2" x 11") sheets from 1st paper tray, using document glass, without Auto Colour Selection and Auto Colour mode, MFP in fully ready condition. May vary depending on operating conditions and environment.

*7: Resolutions higher than 600 dpi are interpolated.

*8: To view XPS files on PCs not running Windows Vista, you must have the XPS Viewer application installed.

*9: Optional MX-HD11 and MX-FWX1 required.

*10: B/W documents only, scanned at under 400-dpi resolution. Max. 800 mm for Internet faxing or when scanning at 600 x 600-dpi resolution.

*11: Measured using Sharp's standard chart (A4 with 6% coverage, B/W). The Quick File Folder shares the HDD with the Job Build function. The storage capacity will be less for colour pages.

*12: Some features require option(s).

*13: Optional MX-PK11 required for Mac OS and EtherTalk.

*14: PCL requires optional MX-HD11 and MX-PB14. PS requires optional MX-HD11, MX-PK11, and MX-PB14. XPS requires optional MX-HD11, MX-PUX1, MX-PB14, and MX-SM10 (1GB).

*15: Some features are not available according to the printer driver used.

*16: Based on Sharp's standard chart with approx. 700 characters (A4 or 8 1/2" x 11" long-edge feeding) at standard resolution in Super G3 mode, 33,600 bps, JBIG compression.

Distributed by:

SHARP



Printed with environmentally friendly vegetable oil-based ink.